

F

E

D

C

B

A

ZONE	SYMBOL	REVISION	APPROVAL	DATE

RoHS
Compliant

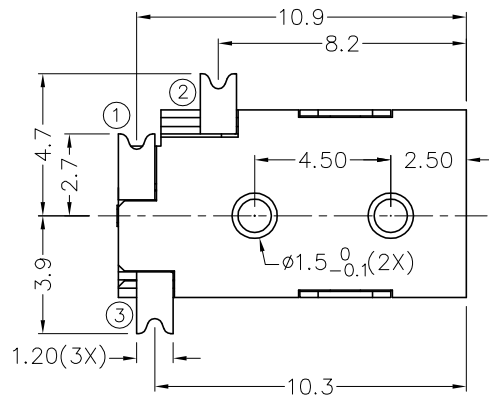
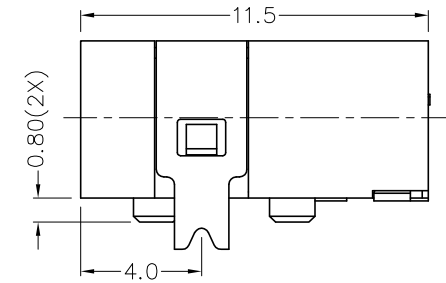
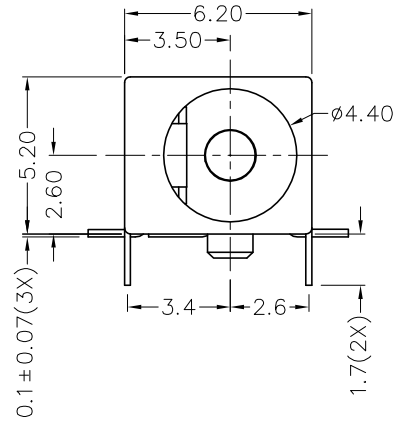
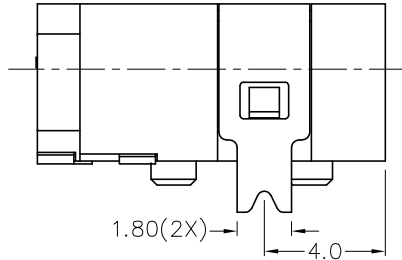
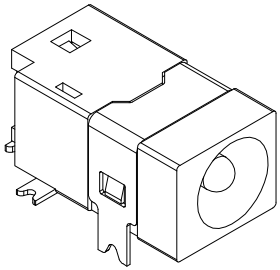

* MATERIAL

TERMINAL 1 : BRASS
 TERMINAL 2 : COPPER ALLOY
 TERMINAL 3 : BRASS
 SHIELD : COPPER ALLOY
 HOUSING : PA6T

MODEL NO.	TDC-068DS2
SCHEMATIC	1 3 2
CENTER PIN	φ1.65mm

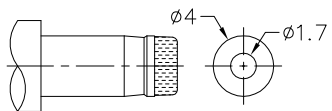
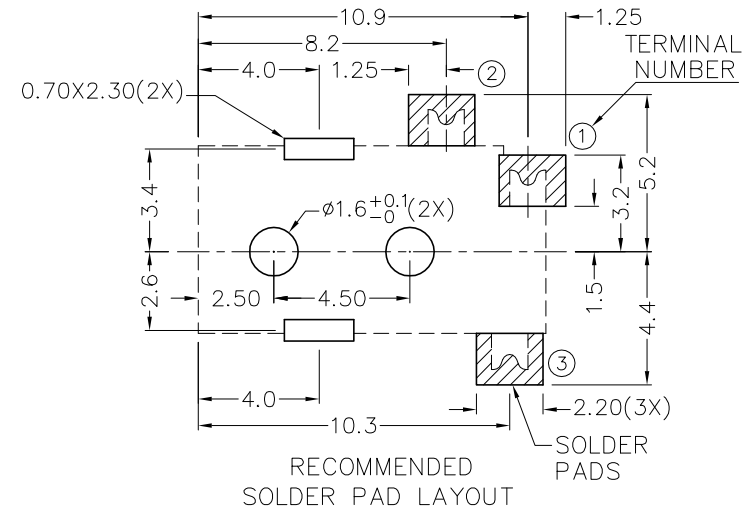

DC MATE PLUG



CHAMPWAY 冠泰電子有限公司
 CHAMPWAY ELECTRONICS CO., LTD.

PART NAME	SMD DC POWER SOCKET	TOLERANCE UNLESS	0.0±0.2	UNIT:	
PART NO.	TDC-068DS2	OTHERWISE SPECIFIED:	0.00±0.1 0.000±0.05	mm	

DESIGN	T.Y.LI	DATE	20-10-2006	SCALE	4:1
DRAWING	T.Y.LI	DATE	20-6-2008	MATERIAL	*
CHECK		DATE		DWG. NO.	TZ\DC068DS2-PA6T/A
APPROVAL		DATE		SHEET	

F

E

D

C

B

A