

F

E

D

C

B

A

RoHS
Compliant

ZONE	SYMBOL	REVISION	APPROVAL	DATE

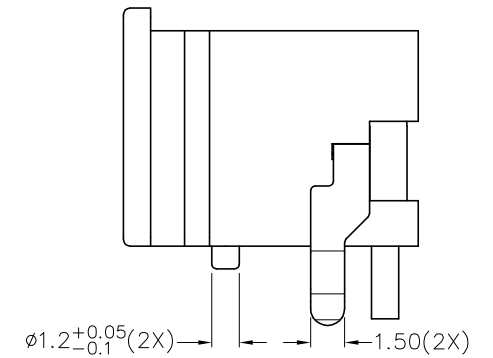
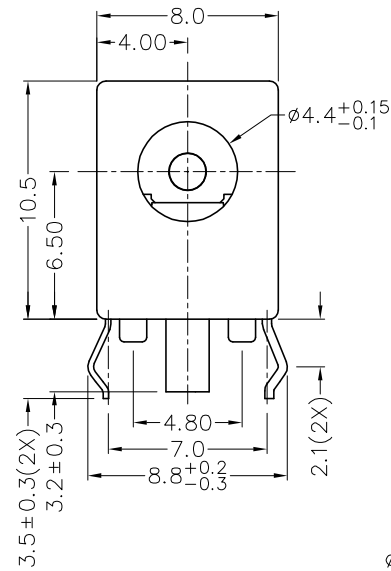
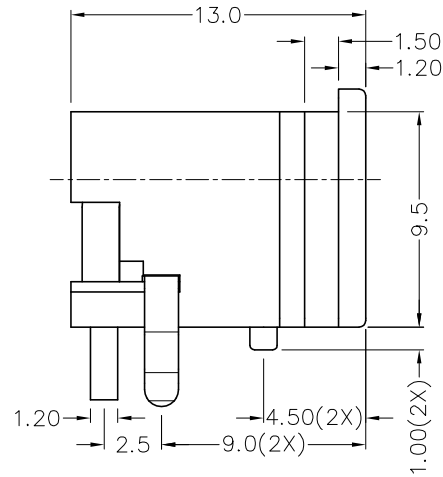
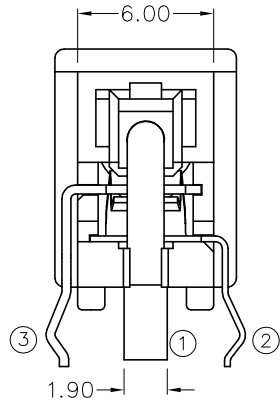
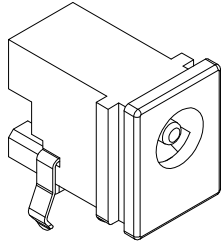

* MATERIAL

TERMINAL 1 : BRASS
TERMINAL 2 : COPPER ALLOY
TERMINAL 3 : BRASS
HOUSING : PBT

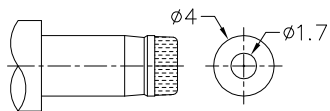
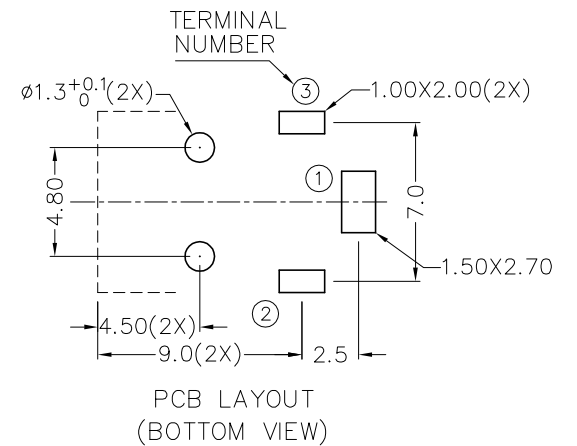

DC MATE PLUG

MODEL NO.	TDC-071
SCHEMATIC	
CENTER PIN	$\phi 1.65\text{mm}$



CHAMPWAY 冠泰電子有限公司
CHAMPWAY ELECTRONICS CO., LTD.

PART NAME	DC POWER SOCKET	TOLERANCE UNLESS	0.0±0.2	UNIT:		DESIGN	G.P.YI	DATE	25-9-2007	SCALE	3:1
PART NO.	TDC-071	OTHERWISE SPECIFIED:	0.00±0.1 0.000±0.05	mm		CHECK	G.P.YI	DATE	25-9-2007	MATERIAL	*
						APPROVAL		DATE		DWG. NO.	TZ\DC071-PBT/A
								DATE		SHEET	

F

E

D

C

B

A