

F

E

D

C

B

A

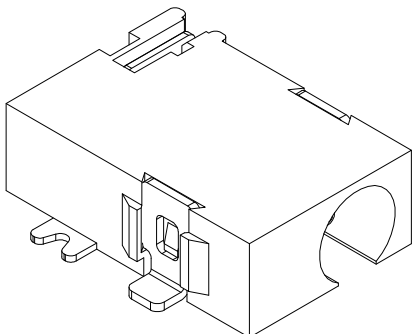

RoHS
Compliant

ZONE	SYMBOL	REVISION	APPROVAL	DATE
		ADDED INDICATION OF COPLANARITY	J.X.KUANG	28-4-2010

1

1

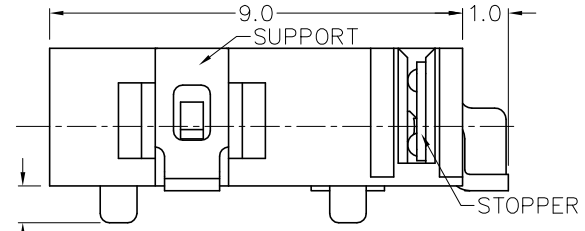
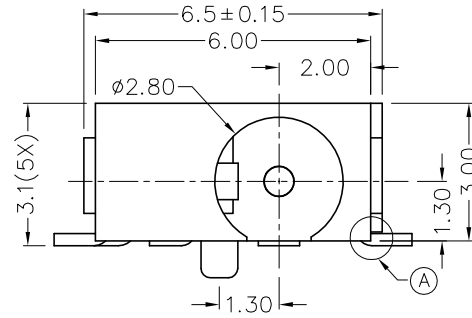
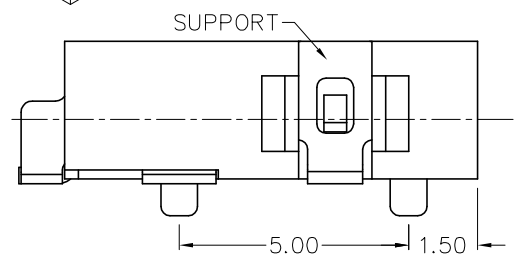

2

2

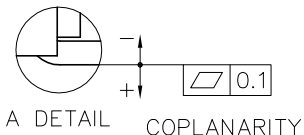
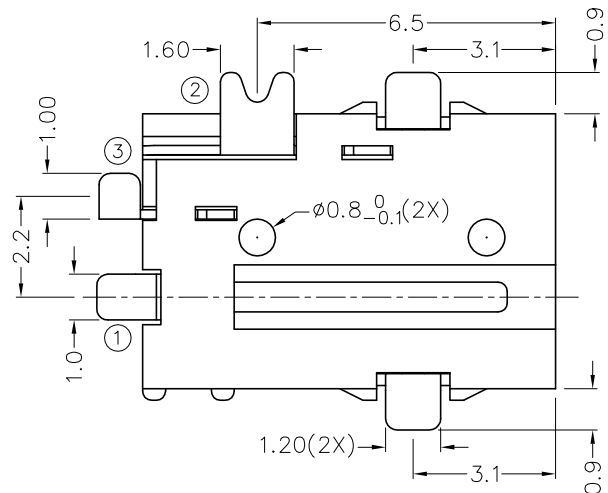

* MATERIAL

- TERMINAL 1 : BRASS
- TERMINAL 2 : COPPER ALLOY
- TERMINAL 3 : BRASS
- SUPPORT : BRASS
- STOPPER : BRASS
- HOUSING : PA6T

MODEL NO.	TDC-057D
SCHEMATIC	
CENTER PIN	φ0.65mm

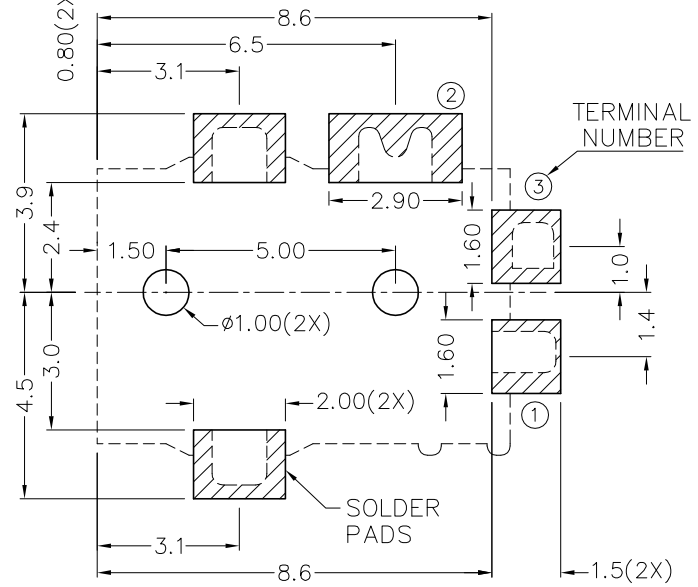

3

3

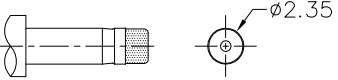

DC MATE PLUG

4

4

RECOMMENDED
SOLDER PAD LAYOUT
(TOP VIEW)



PART NAME	SMD DC POWER SOCKET	TOLERANCE UNLESS 0.0±0.2 0.00±0.1 OTHERWISE SPECIFIED: 0.000±0.05	UNIT: mm		DESIGN	J.X.KUANG	DATE	9-6-2004	SCALE	6:1
					DRAWING	T.Y.LI	DATE	28-4-2010	MATERIAL	*
PART NO.	TDC-057D				CHECK		DATE		DWG. NO.	TZ\DC057D-PA6T/C
					APPROVAL		DATE		SHEET	

F

E

D

C

B

A