

F

E

D

C

B

A

ZONE	SYMBOL	REVISION	APPROVAL	DATE
		ADD MATE PLUG	J.X.KUANG	30-9-2006

RoHS
Compliant

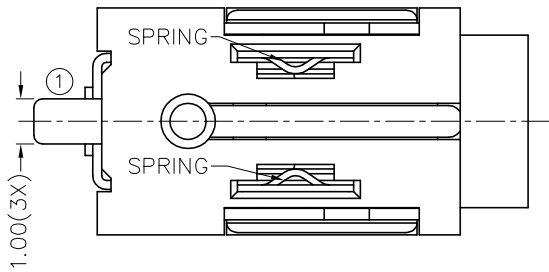
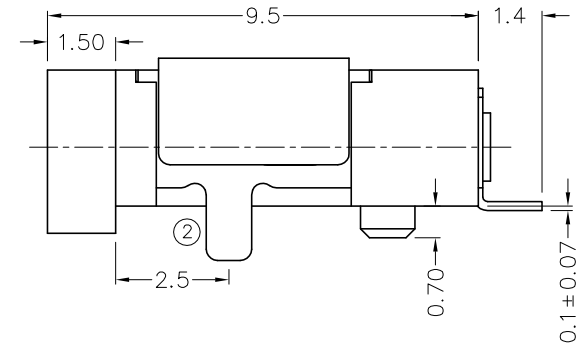
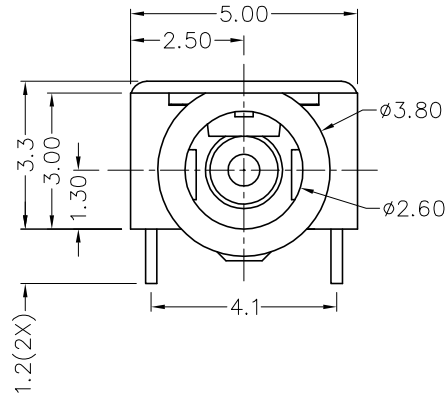
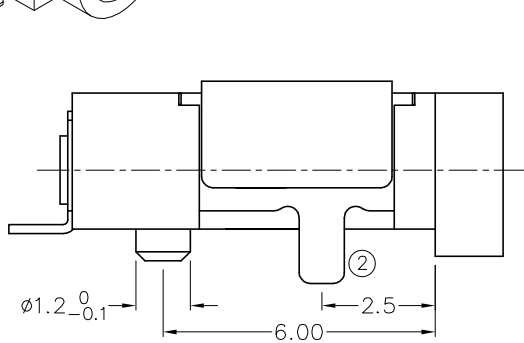
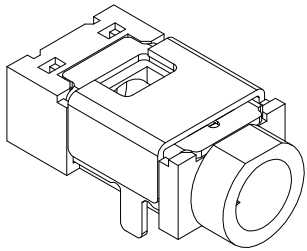

* MATERIAL

CENTRE PIN : COPPER
 TERMINAL 1 : BRASS
 TERMINAL 2 : COPPER ALLOY
 SPRING : STAINLESS STEEL
 SHIELD : BRASS
 HOUSING : PA6T

MODEL NO.	TDC-063DS-3
SCHEMATIC	1 2
CENTER PIN	φ0.65mm

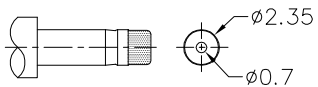
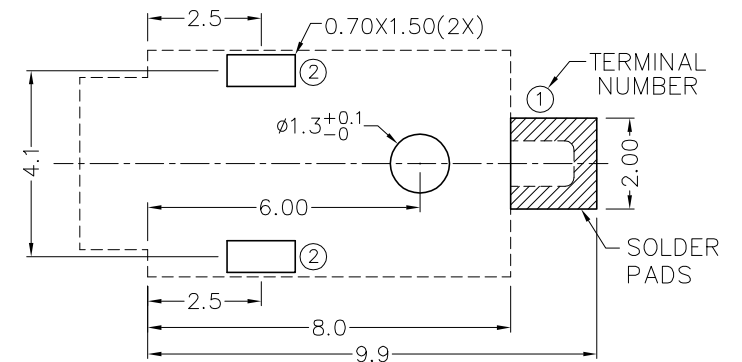

DC MATE PLUG



CHAMPWAY 冠泰電子有限公司
 CHAMPWAY ELECTRONICS CO., LTD.

DESIGN	T.Y.LI	DATE	12-9-2005	SCALE	6:1
DRAWING	L.L.ZHANG	DATE	30-9-2006	MATERIAL	*
CHECK		DATE		DWG. NO.	TZ\DC063DS-3-PA6T/B
APPROVAL		DATE		SHEET	

PART NAME	SMD DC POWER SOCKET	TOLERANCE UNLESS	0.0±0.2	UNIT:	
PART NO.	TDC-063DS-3	OTHERWISE SPECIFIED:	0.00±0.1 0.000±0.05	mm	

F

E

D

C

B

A

DCF-04/A