

F

E

D

C

B

A

ZONE	SYMBOL	REVISION	APPROVAL	DATE
		ADD MATE PLUG	J.X.KUANG	30-9-2006

RoHS
Compliant

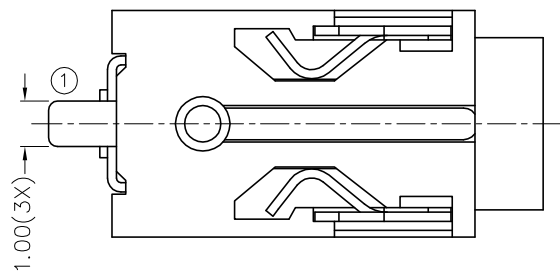
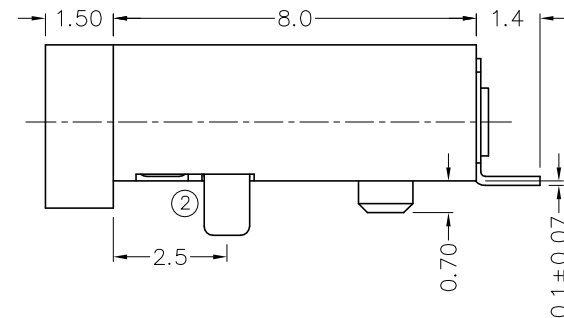
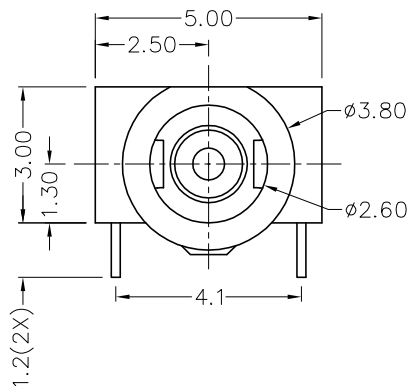
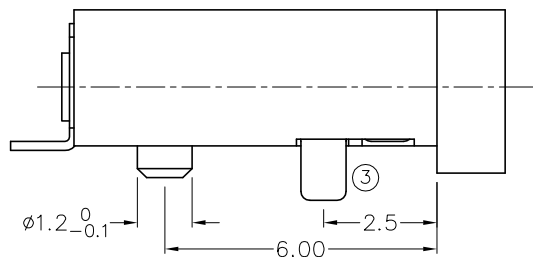
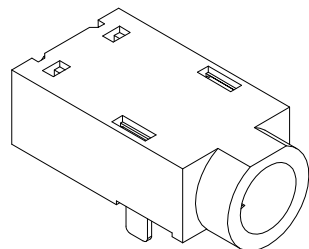

* MATERIAL

CENTRE PIN : COPPER
 TERMINAL 1 : BRASS
 TERMINAL 2 : COPPER ALLOY
 TERMINAL 3 : COPPER ALLOY
 HOUSING : PA6T

MODEL NO.	TDC-064D-3
SCHEMATIC	
CENTER PIN	$\phi 0.65\text{mm}$

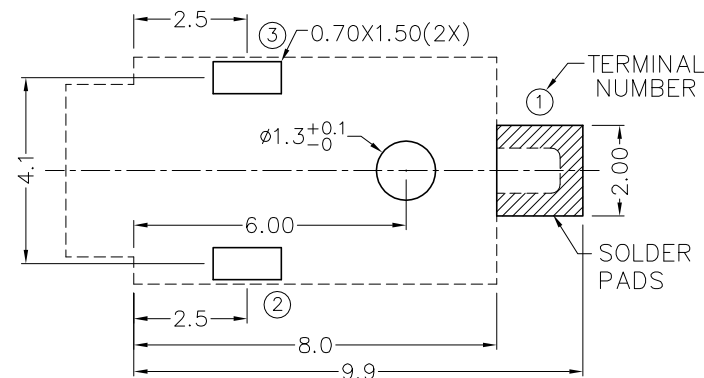

RECOMMENDED
SOLDER PAD LAYOUT

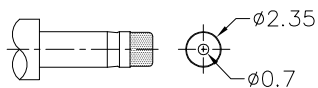

DC MATE PLUG



CHAMPWAY 冠泰電子有限公司
CHAMPWAY ELECTRONICS CO., LTD.

DESIGN	T.Y.LI	DATE	22-9-2005	SCALE	6:1
DRAWING	L.L.ZHANG	DATE	30-9-2006	MATERIAL	*
CHECK		DATE		DWG. NO.	TZ\DC064D-3-PA6T/B
APPROVAL		DATE		SHEET	

PART NAME	SMD DC POWER SOCKET	TOLERANCE UNLESS	0.0±0.2	UNIT:	
PART NO.	TDC-064D-3	OTHERWISE SPECIFIED:	0.00±0.1 0.000±0.05	mm	

F

E

D

C

B

A

DCF-04/A